

Homeowner's User Instructions

SEPTEMBER 2011

Ecodan[®] Aerocyl-me: Air Source Heat Pump and Copper Cylinder

Ecodan Air Source Heat Pump Model Number

- PUAZ-W50VHA(2)-BS
- PUAZ-W85VHA(2)-BS
- PUAZ-HW140VHA(2)-BS / YHA-BS
- PUAZ-HW140VHA-BS(2) / YHA(2)-BS



LIVING ENVIRONMENTAL SYSTEMS

Air Conditioning | Commercial Heating

Domestic Heating | Photovoltaics



Homeowner's User Instructions

Introduction

The Ecodan air source heat pump extracts thermal energy from the outside air and transfers this into a property in the form of hot water as a conventional heating system does. The Ecodan will provide space heating (through radiators or under floor heating) and domestic hot water (taps, showers, etc). Domestic hot water always takes priority over space heating.

The Ecodan Aerocyl-me package is controlled by conventional heating system control equipment. A two channel time clock for ON and OFF periods, a cylinder thermostat for domestic hot water temperature and a room thermostat for space temperature.

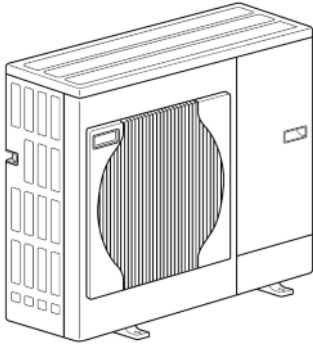
To optimise running costs it is advisable the homeowners seek the cheapest possible electricity tariff. An internet search facility like www.uswitch.com will be able to help.

The homeowner will need to control the Ecodan Aerocyl-me differently to a conventional gas boiler. The use of controls is paramount in achieving low running costs. Although electricity prices are higher than gas or oil, the efficiency of the system means that it requires less energy to supply the same heating demands, thus producing cheaper energy bills. Compared to regular electricity bills it will look higher than usual, but the homeowner should be aware that this bill incorporates heating that is usually achieved though gas or oil.

Please note that heat pumps provide lower flow temperatures to radiators than a conventional gas boiler. Rather than the radiators turning on/off locally as with a gas boiler, heat pumps provide a more consistent lower flow temperature which allows for more efficiency and greater comfort.

Warnings

- Don't allow anyone to interfere with the outdoor unit.
- Don't push any object through the grille area, there is a fast turning fan which could be damaged.
- Don't place objects too close to the outdoor unit.
- Don't ever cover the outdoor unit, air needs to circulate freely around the unit.
- Do be aware that ice may form in the winter period on the ground close to the outdoor unit. Please take particular care.
- Do ensure your installer includes anti-freeze (Alphi-11 or similar), 25% concentration into the heating circuit to prevent icing in the winter.
- Do complete your guarantee registration card and return to the manufacturer. If you do not complete and return the registration card the product will only be under guarantee for 12 months.
- Do take the installers contact details in case you need attention in the future.



Ecodan

This will be located outdoors (most likely to be in the garden) facing away from the property. The air is sucked into the back and used to heat the refrigerant that is sealed within the unit.

Cold air will be expelled from the front of the unit when the Ecodan is operating. The homeowner does not need to make any adjustments to this element of the system.

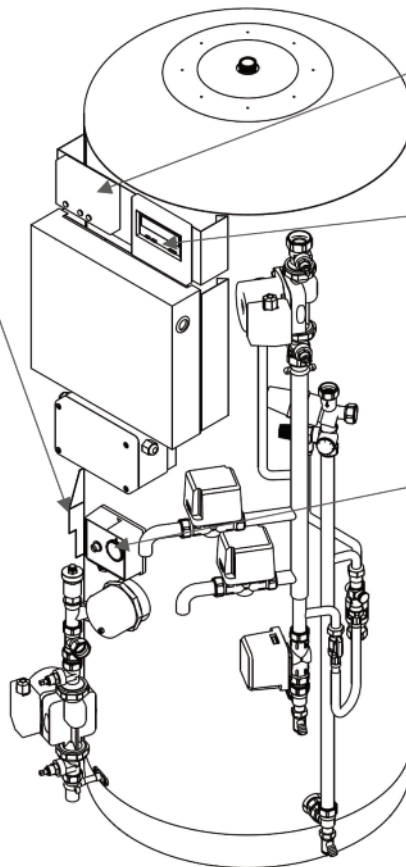
Always ensure the front and back are clear of obstructions.

Immersion Heater
Time Switch
Not necessary to adjust

Aerocyl-me

Copper Cylinder
This will be located indoors in an airing cupboard.

The controllers on this tank are used for installation purposes only and do not need to be adjusted by the homeowner.



Wireless Receiver

PAR-W21MAA
Not necessary to adjust,
the installation engineer
uses this to commission
the system

Hot Water Control
Thermostat
Do not adjust

Room Controllers

Located within a room (placement on a wall will be dependent on installer).

2 channel time clock

Used to control on/off periods for heating and hot water. Instructions on pages 9,10 and 11.

Room Thermostat

Used to control the room temperature. Instructions on pages 7 and 8.



The homeowner should know:

How to switch on power to the Ecodan Aerocyl-me

This will be located inside the property near the mains power switch, it needs to be switched on. The outdoor unit does not need to be touched.

How to switch off power to the Ecodan Aerocyl-me

This will be located inside the property near the mains power switch, it needs to be switched off. If the homeowner is away from the property for several days only switch off the indoor switch. The outdoor unit does not need to be touched, do not switch off at any time.

How to set the radiator temperature

Thermostatic radiator valves control the temperature of the radiator by a built-in sensor, which automatically opens and closes the flow of water into the radiator, maintaining the room at the pre-set temperature. A manual valve can only control the temperature of the radiator regardless of the room temperature. If your property has thermostatic radiator valves, it is recommended that they are fully opened in occupied rooms. The Ecodan works by varying the flow temperatures to radiators depending on room thermostat and outside temperature.

How to set indoor temperature

The room thermostat is needed to set the indoor temperature. Refer to pages 7-8 for user instructions.

How to set the timer

The 2 channel time clock is needed to switch heating and hot water on/off. Refer to pages 9,10 and 11 for user instructions.

How to switch to constant use

Constant running dictated by the 2 channel time clock as this controls on/off periods. Refer to pages 7-8 for user instructions.

Time clock pattern setup

Each channel on the time clock should be programmed to meet the demands of the home occupier in the most efficient way. Hot water will take priority over heating.

For example:

If a homeowner wakes up in the morning and wants a shower at 7am and the property takes an hour to raise to the required room temperature then both channels should be set to 5am, as the vessel will take approximately one hour to achieve temperature before switching to space heating. Some electricity tariffs have cheaper off-peak tariffs (early hours of the morning) that can be used for heat-up times. Always check your electricity tariff by using www.uswitch.com.

If the homeowner does not require hot water again until later in the evening then the time clock should be programmed to heat up approximately one hour prior. This is the most efficient pattern to use rather than maintaining a high storage temperature constantly.

During cold periods the Ecodan will switch into a defrost mode occasionally. At this point the Ecodan will stop producing hot water for inside the dwelling. It will only be for a few minutes and will not cause radiators or under-floor heating to suddenly stop, nor will the heat of the cylinder radically drop. During this process steam may rise from the outdoor unit. This is a perfectly normal process, it is an automatic procedure.

To maintain the efficiency of the Ecodan a weather compensation mode is activated (by the installer). When the outside temperature is colder the flow temperature to the radiators/under-floor is hotter. When warmer outside radiators will be less. This weather compensating curve is pre-set by the installing engineer. Lower flow temperatures mean higher efficiency.

Troubleshooting

Fault	Possible Cause	Solution
Water does not heat up well	Ecodan may not be working to its highest capacity.	Make sure that there is plenty of space around the outdoor unit so air can flow in and out.
	Filter may be dirty and needs to be cleaned.	Cleaning of this filter should be carried out by your installer.
Water or vapour is emitted from the Ecodan unit	During the heating mode, water may form and drop from the heat exchanger on the outdoor unit.	No solution necessary, this will not effect the performance of the Ecodan.
	During the defrosting mode, water on the heat exchanger or the outdoor unit evaporates and water vapour may be emitted.	No solution necessary, pay attention in icy conditions.
Cold water at hot taps	System may be switched off.	Switch on unit and continue operation as usual.
	Hot water used may have exceeded capacity of cylinder.	Tank will automatically fill up as water is used but will take time to heat up. This is dependent upon the size of the cylinder.
	Temperatures set are too low.	Temperature parameters are too low and need to be set by your installer.
Hot water provided but no heating	Time clock has been programmed incorrectly.	Refer to pages 9, 10 and 11 for time clock instructions and set desired times for each function.
Heating provided but no hot water	Time clock has been programmed incorrectly.	Refer to pages 9, 10 and 11 for time clock instructions and set desired times for each function.
Heating does not work at specific times	Time clock has been programmed incorrectly.	Refer to pages 9, 10 and 11 for time clock instructions and set desired times.
Heating and hot water are active at different times during the weekend	The programmable room thermostat has 5/2 split function to create different settings for the weekend.	Refer to pages 7 and 8 for programmable room thermostat settings.
Room becomes too hot when heating is operated	Programmable room thermostat set too high.	Refer to pages 7 and 8 and lower temperatures.
	Heating is not needed during summer months and should be switched off.	Refer to pages 9, 10 and 11 for time clock instructions to stop heating mode.

If these options can not rectify the problems then please contact your local installer so a qualified engineer can fix the problem. Any work carried out by the homeowner will cause the warranty to be void.

Danfoss Thermostat—User Instructions

Your programmable room thermostat allows you to programme at different time periods. You can programme one set of times and temperatures for week days with a different set of temperatures for weekend days, this is referred to as 5/2 day operation.

The thermostat can also be set up by your installer to provide one set of times and temperatures that are repeated each day of the week. This is referred to as 24 hour operation.

The thermostat can also be set by you to provide two different programming blocks which can then be assigned to any day of the week, this is referred to as A/B programme operation.

All thermostats can be set to provide up to 2,4 or 6 time and temperature settings each day. All thermostats feature useful overrides.

TP5000 Si Range

Electronic 5/2 day programmable room thermostat
Mains, Battery and RF versions



Before programming the thermostat press and release the **RESET** button to restart the unit. (Fig. 1)

Setting the Clock and Day

The day and time are set in the factory and therefore it will not normally be necessary to do this on site. Changes between summer and winter time are handled automatically by the unit.

Accepting the Factory Pre-settings

The TP5000 Si has pre-set times already programmed in, which often suit most people (see table below).

Note: If set up for 4 events per day, events 3 & 4 are skipped. If set up for 2 events per day, events 2, 3, 4 & 5 are skipped and the events are re-numbered.

Mon-Fri

Event	Time	Temp. °C
1	06:30	20
2	08:30	15
3	11:30	20
4	13:30	15
5	16:30	21
6	22:30	15

Sat-Sun

Event	Time	Temp. °C
1	07:30	20
2	09:30	20
3	11:30	20
4	13:30	20
5	16:30	20
6	22:30	15

To adjust the factory pre-settings & set your own time and temperature programmes

For Days 1-5 (weekdays)

- Press **PROG** (Fig. 2) 3 times to show the 1st pre-set time and temperature (Event 1 Days 1,2,3,4,5) (Fig. 3).
- Use **+ or -** buttons (Fig. 4) to adjust the **TIME** (press and hold to change in 10 min increments).
- Use **A or V** buttons (Fig. 5) to adjust the **TEMPERATURE**.
- Press **PROG** (Fig. 2) to move to next preset time & temp (Event 2) (Fig. 6).
- Repeat steps b, c & d for programming Events 3, 4, 5 & 6.

For Days 6-7 (weekends)

- Press **PROG** (Fig. 2) to show 1st pre-set time and temperature (Event 1 Days 6-7) (Fig. 7).
- Repeat steps b, c and d above to programme time and temperature events for the weekend.

Returning to RUN mode

Press **PROG** (Fig. 2) – the colon in the LCD display will start to flash (Fig. 8).

Fig.1

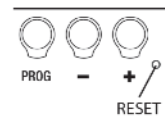


Fig.2



Fig.3



Fig.4

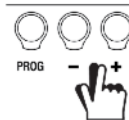


Fig.5



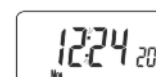
Fig.6



Fig.7



Fig.8



Temporary User Overrides

The TP5000 has several useful overrides which can be selected without affecting the thermostat programming.

- **Selection of time or actual room temperature in main LCD display** – press **+** and **-** together to change between settings (Fig. 9).
- **Temporary override of programmed temperature** – press **Λ** or **V** until required temperature is displayed (override will automatically cancel at beginning of next programmed event) (Fig. 10).
- **Frost Protection** – a constant low temperature can be selected whilst away from home - press **Λ** and **V** together (Fig. 11). Then use **Λ** or **V** to select the required temperature. To return to automatic programming press **Λ** and **V** together again.

Fig.9

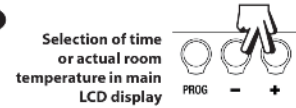


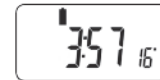
Fig.10



Fig.11



Fig.12



Battery Replacement

- A low battery symbol will flash in the LCD display (Fig. 12)
- You have 15 days to replace the battery before the unit will switch off.
- Remove old batteries and insert new ones. All settings including time are maintained.
- Press and release the **RESET** button to restart the unit. (Fig. 1)

NB. If the display ever goes blank during normal operation, the batteries will need to be renewed with high quality alkaline cells. The reset button should be pressed to restart the unit. All times, dates and events will be retained and need not be re-programmed.

IMPORTANT RF Models only

To ensure that the factory programmes are set and the micro-computer is operating correctly it is essential that you press and hold the **RESET** button before you begin any commissioning or programming.

Commissioning Instructions

If the thermostat and the receiver have been supplied together in a combined pack, the units have been paired in the factory and no commissioning is required (RX1 only).

To tune the RX receiver to the frequency of the thermostat signal, follow steps 1-5 below.

Step 1

TP5000-RF Si - Reset the unit by pressing the recessed reset button.

Step 2

Press and hold **V** and **+** buttons (fig. 13) for 3 seconds (TP5000 RF Si now transmits unique signal continuously for 3 minutes).

Step 3

RX1 - Press and hold buttons **PROG** and **CH1** for 3 seconds until green light flashes once.

(Fig. 14)

Step 4 (Fig.14)

RX2 (if applicable)

Stat 1 - perform steps 1-3 and 5.

Stat 2 - perform steps 1-2 and then press **PROG** and **CH2** on **RX2**.

RX3 (if applicable)

Stat 1 - perform steps 1-3 and 5.

Stat 2 - perform steps 1-2 and then press **PROG** and **CH2** on **RX3** then step 5.

Stat 3 - perform steps 1-2 and then press **PROG** and **CH3** on **RX3**.

Step 5

TP5000SI-RF - Press **V** or **Λ** to select temperature - the unit will revert back to operating mode.

Fig.13

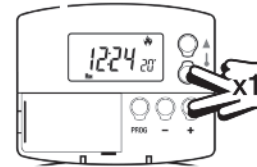


Fig.14

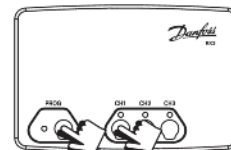


Fig.15



Service Interval Timer

If the property is owned by a landlord he may, for gas safety reasons, have instructed the installer to set the service interval timer.

If set a visual and audible warning will alert you that the boiler will need servicing within the next 28 days. This warning is repeated each day at noon. (Fig. 15)

If the boiler is not serviced within 28 days the daily audible warning will sound continuously and can only be cancelled each day by pressing any button on the unit.

In addition, all overrides and programming buttons will be disabled and the heating and hot water will only operate for 15 minutes in each programmed hour.

As this is a gas safety feature only an installer can reset the service interval timer. This will be done as part of the boiler service as part of the boiler service.

Danfoss 2 Channel Timeclock – User Instructions

The FP715 Si allows you to switch your heating and hot water on and off at times that suit you.

Your programme has had the date and time set up during manufacture and will automatically change between Greenwich Mean Time and British Summer Time.

You can programme up to 3 ON/OFF times per day for the heating and hot water and the two systems can be operated independently.

FP715 Si Electronic, 2-channel full programmer for heating & hot water with service interval timer



Before beginning programming, you should reset the unit. Open the flap on the front of the clock. Press the **RESET** button using a non-metallic object (e.g. end of a biro pen top). This will clear all previous pre-set programmes. (Fig. 1)

A. Setting the correct Time and Day

The time and date are set in the factory and do not need to be set.

B. Accepting the Factory Settings

The FP715 Si comes ready programmed with a set of times to suit the average household.

If you wish to alter these settings follow instructions below.

Your installer will have set your unit to operate in one of the following modes:

5/2 day - a set of programmes for weekdays and another for weekends (Section C)

7 day - different settings for each day of the week (Section D)

24 hour - one set of programmes for the whole week (Section E)

Please follow relevant instructions below.

C. Programming the Heating - 5/2 day mode

1. Press **PROG** (Fig. 2) until **SET CH ON TIME** appears at the top of the display and **MOTUWETHFR** appears at the bottom of the display (Fig. 6). Use the **+ and -** buttons (Fig. 3) to set the time you would like your heating to first come on in the morning (Event 1).
2. Press **NEXT ON/OFF** once only (Fig. 7). Use the **+ and -** buttons (Fig. 3) to set the time you want your heating to go off (Event 2). To move to the next setting, i.e. when you would like your heating to come on again (Event 3) press the **NEXT ON/OFF** button once only.
3. Continue programming the central heating ON and OFF times for weekday Events 4, 5 & 6 as in Step 2.
4. Press the **DAY** button once (Fig. 4) and **SASU** will appear at the bottom of the display (Fig. 8). Programme new ON/OFF times by pressing the **NEXT ON/OFF** button (Fig. 7) once to move to the next setting and using the **+ and -** buttons (Fig. 3) to set the time you want.
5. Press **DAY** button (Fig. 4) to return display to **MOTUWETHFR**, ready to programme the Hot Water.
6. **Proceed to Section F.**

D. Programming the Heating - 7 day mode

1. Press **PROG** (Fig. 2) until **SET CH ON TIME** appears at the top of the display and day of week (e.g. **MO**) appears at the bottom of the display (Fig. 9). Use the **+ and -** buttons (Fig. 3) to set the time you want your heating to first come on in the morning (Event 1).
2. Press **NEXT ON/OFF** (Fig. 7) to move to **Event 2**. Continue programming the central heating ON and OFF times in this way by using the **+ and -** buttons to set the time you want and pressing the **NEXT ON/OFF** button to move to the next setting (Figs. 3 & 7).
3. Press **DAY** button once only (Fig. 4), the next day (e.g. **TU**) will appear at the bottom of the display. Continue programming for the rest of the week by pressing the **NEXT ON/OFF** button (Fig. 7) to move to the next setting, using the **+ and -** buttons to amend the time, and by pressing **DAY** to advance to the next day (Figs. 7, 3 & 4).
4. Press **DAY** button (Fig. 5) to return display to **MO**, ready to programme the Hot Water
5. **Proceed to Section F.**

Fig. 1



Fig. 2

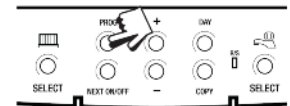


Fig. 3

To alter clock & ON/OFF times

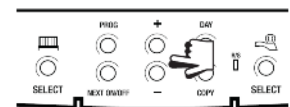


Fig. 4

To move to next day or to weekend

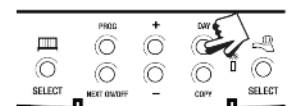


Fig. 5



Fig. 6



Fig. 7

To move to next event

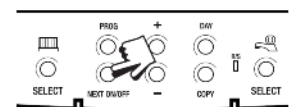
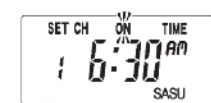


Fig. 8



E. Programming the Heating - 24 hour mode

1. Press **PROG** (Fig. 2) until **SET CH ON TIME** appears at the top of the display. Use the **+** and **-** buttons (Fig. 3) to set the time you want your heating to first come on in the morning (**Event 1**).
2. Press **NEXT ON/OFF** (Fig. 7) to move to **Event 2**. Continue programming the central heating ON and OFF times in this way by using the **+** and **-** buttons to set the time and pressing the **NEXT ON/OFF** button to move to the next setting (Figs. 3 & 7).
3. Proceed to Section F.

N.B. Depending how your installer has set the clock you will be able to programme either 2 or 3 ON/OFFs per day. If your clock has been installed to allow 3 ON/OFFs and you do not wish to use one of the ON/OFF settings, simply programme the ON time to be the same as the OFF time and the setting will not operate.

F. Programming the Hot Water

To set the hot water programme press the **PROG** button (Fig. 2) until the **SET HW ON TIME** appears on the display (Fig. 10).

Set the hot water programme in the same way as the heating programme, using the **+** and **-** buttons to alter the time (Fig. 12), by pressing the **NEXT ON/OFF** button (Fig. 11) to move to the next setting and by pressing **DAY** (Fig. 13) to advance through days of the week (7 day mode) or to advance to Saturday and Sunday programming (5/2 day mode).

Finally press **PROG** (Fig. 2) to return the unit to **run mode** (Fig. 5).

G. Running your Programme

To run the central heating programme: press the **SELECT** button next to the symbol of a radiator (Fig. 14).

To run the hot water programme: press the **SELECT** button next to the tap symbol (Fig. 14).

As you press each of the **SELECT** buttons the display will change between **ON**, **OFF**, **ALLDAY** and **AUTO**. Select the option you require depending on your circumstances, time of the year etc (Fig. 15).

- **AUTO** = the heating or hot water come on and go off at the programmed times
- **ON** = the heating or hot water will remain on constantly
- **OFF** = the heating or hot water will not come on
- **ALLDAY** = the clock will turn the heating or hot water on at the first programmed ON and will leave it on until your last programmed OFF

H. Temporary Override Buttons

The **grey buttons next to the radiator** are the **heating** override buttons (Fig. 16)

The **grey buttons next to the tap** are the **hot water** override buttons (Fig. 16)

+1HR = the heating/hot water will remain on for an extra hour. If it is pressed whilst the programme is off, the heating/hot water will come on immediately for 1 hour then go off.

MAN = if this button is pressed when either system is on, then that system will go OFF until the next programmed ON. If this button is pressed when either system is OFF, that system will come ON until the next programmed OFF.

NB. These over-rides are only temporary and do not affect the preset programmes.

I. Winter Time / Summer Time Clock

The change between winter and summer time is handled automatically and will occur on the correct date in Spring and Autumn.

J. Service Interval Timer

If the property is owned by a landlord he may, for gas safety reasons, have instructed the installer to set the service interval timer.

If set a visual and audible warning will alert you that the boiler will need servicing within the next 28 days. This warning is repeated each day at noon. (Fig. 17)

If the boiler is not serviced within 28 days the daily audible warning will sound continuously and can only be cancelled each day by pressing any button on the unit.

In addition, all overrides and programming buttons will be disabled and the heating and hot water will only operate for 15 minutes in each programmed hour.

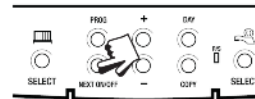
As this is a gas safety feature only an installer can reset the service interval timer. This will be done as part of the boiler service.



Fig. 10

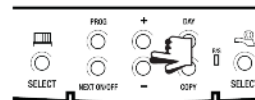


Fig. 11



To move to next event

Fig. 12



To alter ON/OFF times

Fig. 13



To move to next day or to weekend

Fig. 14

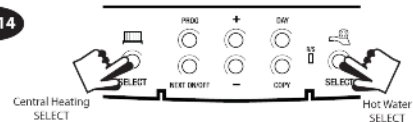


Fig. 15



Fig. 16

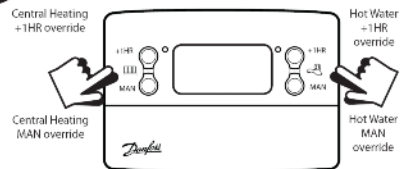


Fig. 17



E. Programming the Heating - 24 hour mode

1. Press **PROG** (Fig. 2) until **SET CH ON TIME** appears at the top of the display. Use the **+** and **-** buttons (Fig. 3) to set the time you want your heating to first come on in the morning (**Event 1**).
2. Press **NEXT ON/OFF** (Fig. 7) to move to **Event 2**. Continue programming the central heating ON and OFF times in this way by using the **+** and **-** buttons to set the time and pressing the **NEXT ON/OFF** button to move to the next setting (Figs. 3 & 7).
3. Proceed to Section F.

N.B. Depending how your installer has set the clock you will be able to programme either 2 or 3 ON/OFFs per day. If your clock has been installed to allow 3 ON/OFFs and you do not wish to use one of the ON/OFF settings, simply programme the ON time to be the same as the OFF time and the setting will not operate.

F. Programming the Hot Water

To set the hot water programme press the **PROG** button (Fig. 2) until the **SET HW ON TIME** appears on the display (Fig. 10).

Set the hot water programme in the same way as the heating programme, using the **+** and **-** buttons to alter the time (Fig. 12), by pressing the **NEXT ON/OFF** button (Fig. 11) to move to the next setting and by pressing **DAY** (Fig. 13) to advance through days of the week (7 day mode) or to advance to Saturday and Sunday programming (5/2 day mode).

Finally press **PROG** (Fig. 2) to return the unit to **run mode** (Fig. 5).

G. Running your Programme

To run the central heating programme: press the **SELECT** button next to the symbol of a radiator (Fig. 14).

To run the hot water programme: press the **SELECT** button next to the tap symbol (Fig. 14).

As you press each of the **SELECT** buttons the display will change between **ON**, **OFF**, **ALLDAY** and **AUTO**. Select the option you require depending on your circumstances, time of the year etc (Fig. 15).

- **AUTO** = the heating or hot water come on and go off at the programmed times
- **ON** = the heating or hot water will remain on constantly
- **OFF** = the heating or hot water will not come on
- **ALLDAY** = the clock will turn the heating or hot water on at the first programmed ON and will leave it on until your last programmed OFF

H. Temporary Override Buttons

The **grey buttons next to the radiator** are the **heating** override buttons (Fig. 16)

The **grey buttons next to the tap** are the **hot water** override buttons (Fig. 16)

+1HR = the heating/hot water will remain on for an extra hour. If it is pressed whilst the programme is off, the heating/hot water will come on immediately for 1 hour then go off.

MAN = if this button is pressed when either system is on, then that system will go OFF until the next programmed ON. If this button is pressed when either system is OFF, that system will come ON until the next programmed OFF.

NB. These over-rides are only temporary and do not affect the preset programmes.

I. Winter Time / Summer Time Clock

The change between winter and summer time is handled automatically and will occur on the correct date in Spring and Autumn.

J. Service Interval Timer

If the property is owned by a landlord he may, for gas safety reasons, have instructed the installer to set the service interval timer.

If set a visual and audible warning will alert you that the boiler will need servicing within the next 28 days. This warning is repeated each day at noon. (Fig. 17)

If the boiler is not serviced within 28 days the daily audible warning will sound continuously and can only be cancelled each day by pressing any button on the unit.

In addition, all overrides and programming buttons will be disabled and the heating and hot water will only operate for 15 minutes in each programmed hour.

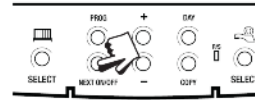
As this is a gas safety feature only an installer can reset the service interval timer. This will be done as part of the boiler service.



Fig. 10

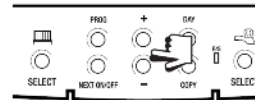


Fig. 11



To move to next event

Fig. 12



To alter ON/OFF times

Fig. 13



To move to next day or to weekend

Fig. 14

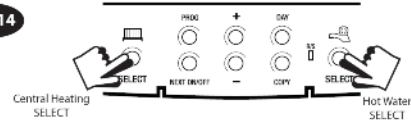


Fig. 15



Fig. 16

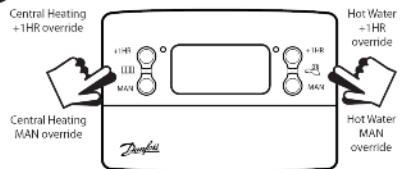


Fig. 17





Telephone: 01707 282880

After Sales Service: 0161 866 6089

email: heating@meuk.mee.com

web: www.domesticheating.mitsubishielectric.co.uk

UNITED KINGDOM Mitsubishi Electric Europe Living Environmental Systems Division
 Travellers Lane, Hatfield, Hertfordshire, AL10 8XB, England
 General Enquiries Telephone: 01707 282880 Fax: 01707 278881

IRELAND Mitsubishi Electric Europe Westgate Business Park, Ballymount, Dublin 24, Ireland
 Telephone: Dublin (01) 419 8800 Fax: Dublin (01) 419 8890 International code: (003531)

Country of origin: United Kingdom – Japan – Thailand – Malaysia. ©Mitsubishi Electric Europe 2011. Mitsubishi and Mitsubishi Electric are trademarks of Mitsubishi Electric Europe B.V. The company reserves the right to make any variation in technical specification to the equipment described, or to withdraw or replace products without prior notification or public announcement. Mitsubishi Electric is constantly developing and improving its products. All descriptions, illustrations, drawings and specifications in this publication present only general particulars and shall not form part of any contract. All goods are supplied subject to the Company's General Conditions of Sale, a copy of which is available on request. Third-party product and brand names may be trademarks or registered trademarks of their respective owners.

Printed in September 2011 SAP No. 233840



www.greengateway.mitsubishielectric.co.uk
 Mitsubishi Electric's commitment
 to the environment